

SPEC SHEET

DCF1300-T0810

8.3 GHz to 8.8 GHz

DCF Drop-in ISOLATORS & CIRCULATORS

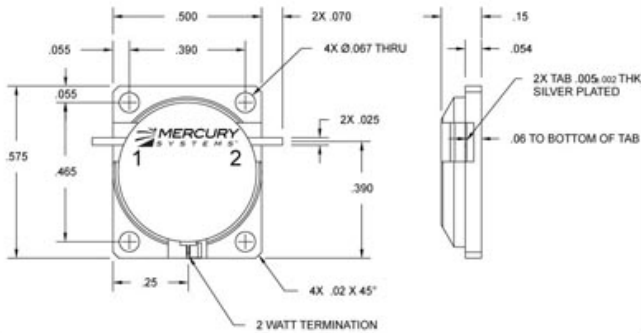

Specifications

RF Frequency	8.3 GHz to 8.8 GHz
Isolation	20 dB (min)
Insertion Loss	0.4 dB (max)
VSWR	1.25:1
Peak Power	50 Watts (max)
Average Power	5 Watts (max)
Power Forward	35 Watts
Power Reverse	2 Watts
Package Size	0.50 x 0.575 x 0.15"

Environmental

Operating Temperature	-40 to 85 °C
-----------------------	--------------

Notes



Microwave RF Components | Manteca, CAL | 1-209-825-3977 | rf.mrcy.com
 Specifications subject to change without notice

