

SPEC SHEET

# DNF1300-T0501

## 5.4 GHz to 5.901 GHz

### DNF Drop-in ISOLATORS & CIRCULATORS

### Specifications

RF Frequency	5.4 GHz to 5.901 GHz
Isolation	23 dB (min)
Insertion Loss	0.4 dB (max)
VSWR	1.15:1
Peak Power	50 Watts (max)
Average Power	5 Watts (max)
Package Size	0.50 x 0.50 x 0.21"

### Environmental Notes

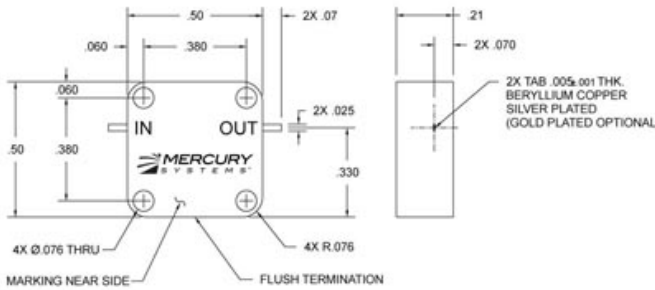

Microwave RF Components | Manteca, CAL | 1-209-825-3977 | [rf.mrcy.com](http://rf.mrcy.com)  
 Specifications subject to change without notice

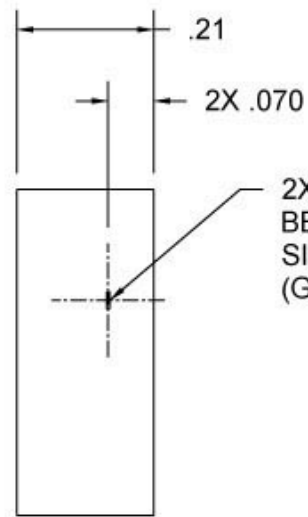
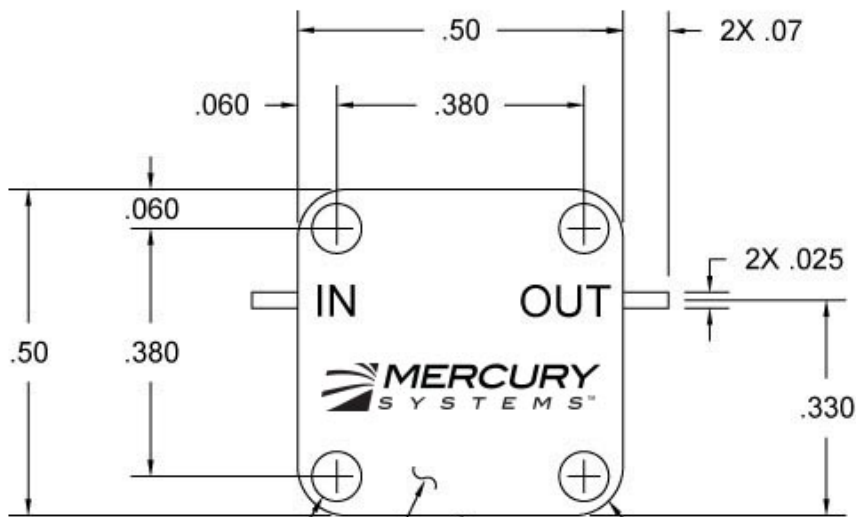

2X TAB .005±.001 THK.  
 BERYLLIUM COPPER  
 SILVER PLATED  
 (GOLD PLATED OPTIONAL)

4X Ø.076 THRU

4X R.076

MARKING NEAR SIDE

FLUSH TERMINATION