

SPEC SHEET

DNF1300-T0600

6.4 GHz to 7.8 GHz

DNF Drop-in ISOLATORS & CIRCULATORS

Specifications

RF Frequency	6.4 GHz to 7.8 GHz
Isolation	20 dB (min)
Insertion Loss	0.5 dB (max)
VSWR	1.25:1
Peak Power	50 Watts (max)
Average Power	5 Watts (max)
Package Size	0.50 x 0.50 x 0.21"

Environmental Notes

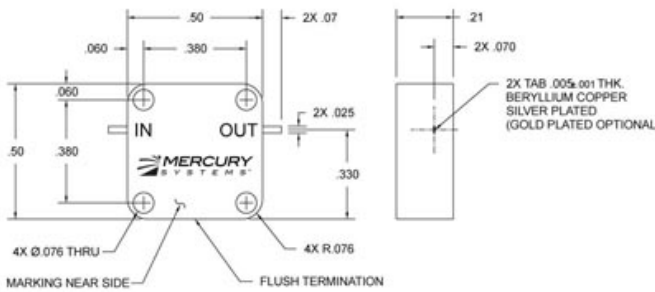

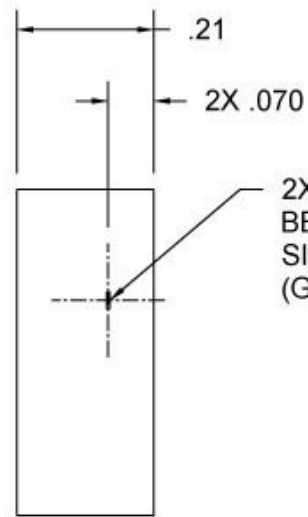
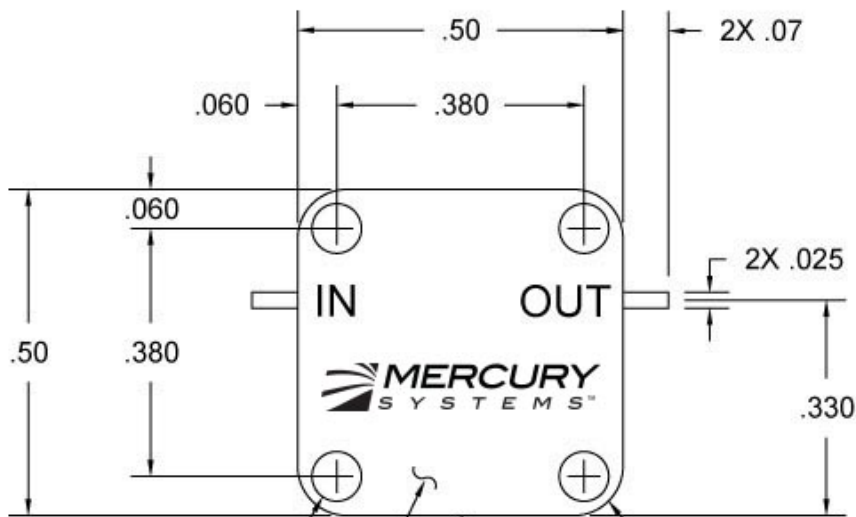

2X TAB .005±.001 THK.
 BERYLLIUM COPPER
 SILVER PLATED
 (GOLD PLATED OPTIONAL)

4X Ø.076 THRU

4X R.076

MARKING NEAR SIDE

FLUSH TERMINATION