

SPEC SHEET

DNF2540-T0025

0.86 GHz to 0.96 GHz

DNF Drop-in ISOLATORS & CIRCULATORS

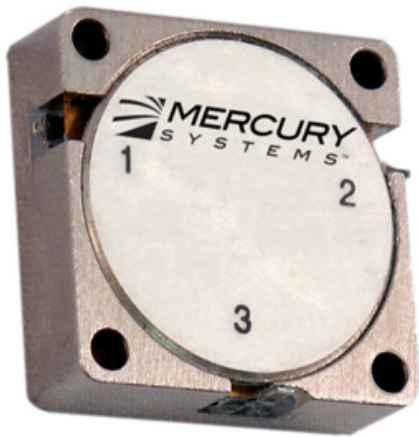

Specifications

RF Frequency	0.86 GHz to 0.96 GHz
Isolation	18 dB (min)
Insertion Loss	0.5 dB (max)
VSWR	1.3:1
Peak Power	1 Watts (max)
Average Power	100 Watts (max)
Package Size	1.00 x 1.00 x 0.30"

Environmental Notes

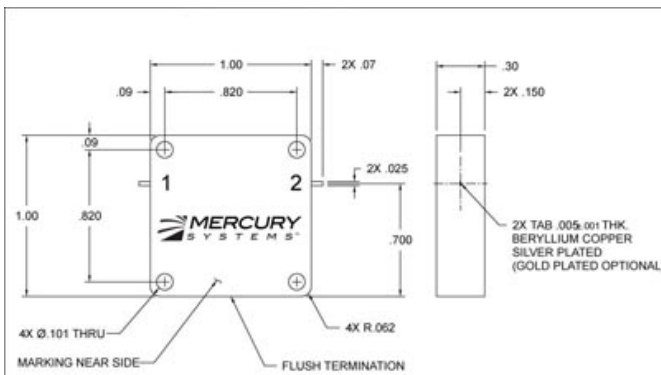

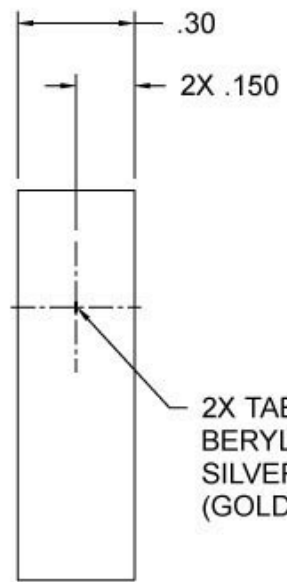
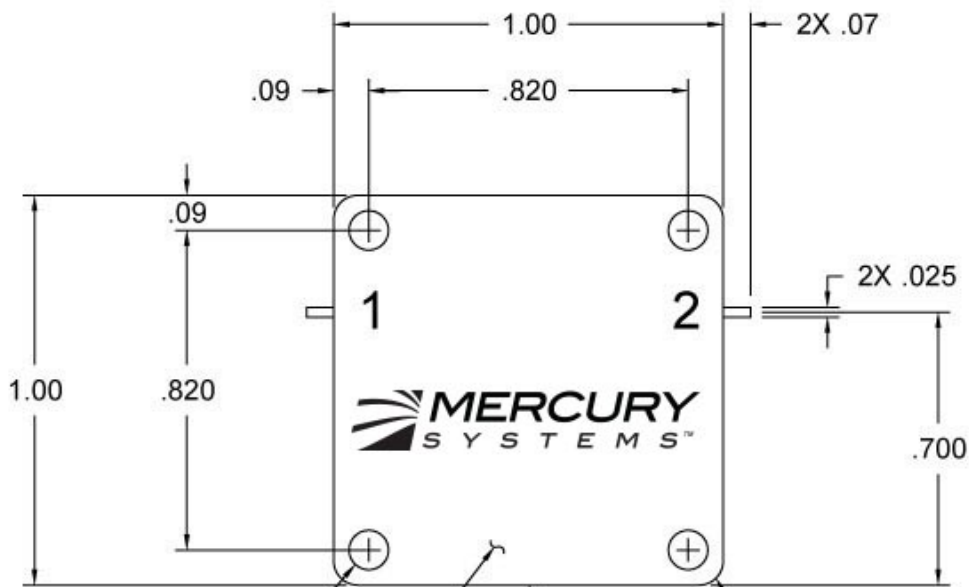

2X TAB .005-.001 THK.
 BERYLLIUM COPPER
 SILVER PLATED
 (GOLD PLATED OPTIONAL)

4X Ø.101 THRU

MARKING NEAR SIDE

4X R.062

FLUSH TERMINATION