

SPEC SHEET

SMD1300-T1295

12.7 GHz to 13.2 GHz

Stripline ISOLATORS & CIRCULATORS

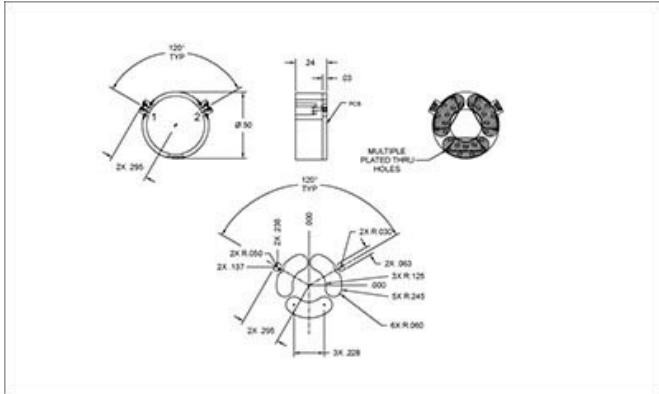

Specifications

RF Frequency	12.7 GHz to 13.2 GHz
Isolation	20 dB (min)
Insertion Loss	0.5 dB (max)
VSWR	1.25:1
Power Forward	5 Watts
Power Reverse	1 Watts
Package Size	0.5"

Environmental

Operating Temperature	-35 to 85 °C
-----------------------	--------------

Notes



Microwave RF Components | Manteca, CAL | 1-209-825-3977 | rf.mrcy.com
 Specifications subject to change without notice

