

SPEC SHEET

# T-007S10

## 7.7 GHz to 8.3 GHz

Communication Band Coaxial ISOLATORS & CIRCULATORS

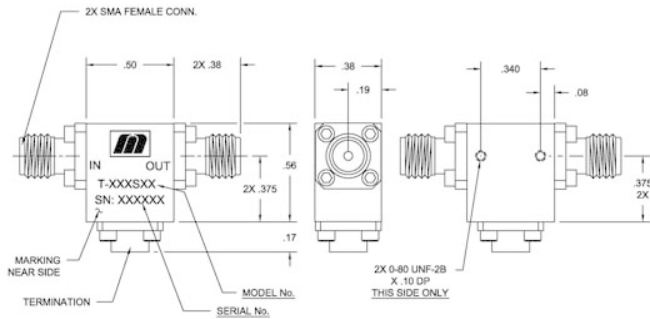

### Specifications

RF Frequency	7.7 GHz to 8.3 GHz
Isolation	23 dB (min)
Insertion Loss	0.4 dB (max)
VSWR	1.15:1
Peak Power	50 Watts (max)
Average Power	1 Watts (max)
Package Size	0.50 x 0.56 x 0.38"

### Environmental Notes



Microwave RF Components | Manteca, CAL | 1-209-825-3977 | [rf.mrcy.com](http://rf.mrcy.com)  
 Specifications subject to change without notice

