

SPEC SHEET

T-012S15

12.3 GHz to 13.2 GHz

Communication Band Coaxial ISOLATORS & CIRCULATORS

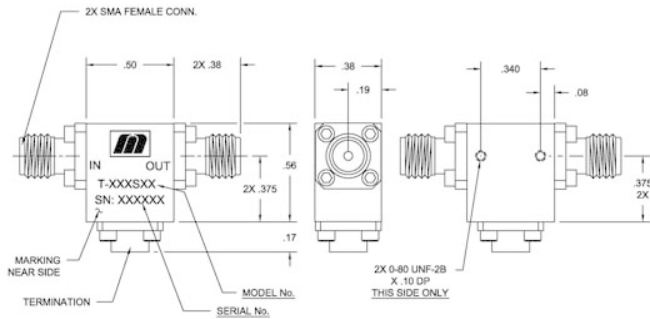

Specifications

RF Frequency	12.3 GHz to 13.2 GHz
Isolation	20 dB (min)
Insertion Loss	0.5 dB (max)
VSWR	1.25:1
Peak Power	10 Watts (max)
Average Power	1 Watts (max)
Package Size	0.50 x 0.56 x 0.38"

Environmental Notes



Microwave RF Components | Manteca, CAL | 1-209-825-3977 | rf.mrcy.com
 Specifications subject to change without notice

