

SPEC SHEET

T-014S15

14.5 GHz to 15.5 GHz

Communication Band Coaxial ISOLATORS & CIRCULATORS

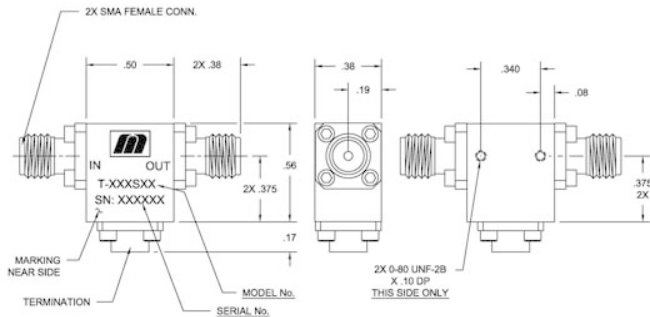

Specifications

RF Frequency	14.5 GHz to 15.5 GHz
Isolation	23 dB (min)
Insertion Loss	0.3 dB (max)
VSWR	1.22:1
Peak Power	10 Watts (max)
Average Power	1 Watts (max)
Package Size	0.50 x 0.56 x 0.38"

Environmental Notes



Microwave RF Components | Manteca, CAL | 1-209-825-3977 | rf.mrcy.com
 Specifications subject to change without notice

