

SPEC SHEET

T-1006S01 6 GHz to 18 GHz

Broadband Coaxial ISOLATORS & CIRCULATORS

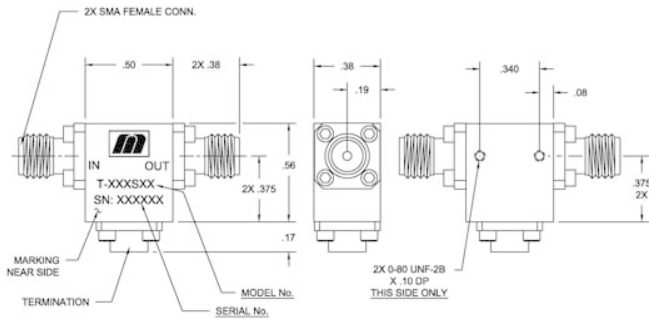

Specifications

RF Frequency	6 GHz to 18 GHz
Isolation	13 dB (min)
Insertion Loss	1 dB (max)
VSWR	1.6:1
Peak Power	15 Watts (max)
Average Power	2 Watts (max)
Package Size	0.50 x 0.56 x 0.38"

Environmental

Operating Temperature	-40 to 85 °C
-----------------------	--------------

Notes



Microwave RF Components | Manteca, CAL | 1-209-825-3977 | rf.mrcy.com
Specifications subject to change without notice

