

SPEC SHEET

T-200S06

0.3 GHz to 0.4 GHz

Communication Band Coaxial ISOLATORS & CIRCULATORS

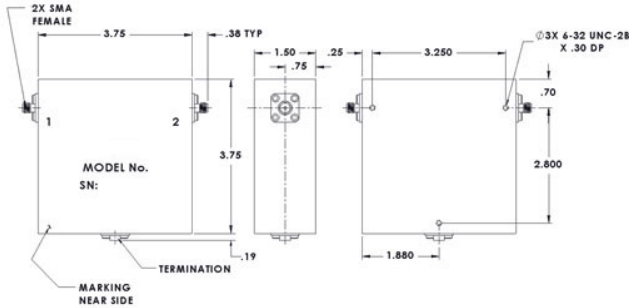

Specifications

RF Frequency	0.3 GHz to 0.4 GHz
Isolation	18 dB (min)
Insertion Loss	0.5 dB (max)
VSWR	1.3:1
Peak Power	1000 Watts (max)
Average Power	100 Watts (max)
Package Size	3.75 x 3.75 x 1.50"

Environmental Notes



Microwave RF Components | Manteca, CAL | 1-209-825-3977 | rf.mrcy.com
Specifications subject to change without notice

