

SPEC SHEET

T-610S01

10 GHz to 20 GHz

Broadband Coaxial ISOLATORS & CIRCULATORS

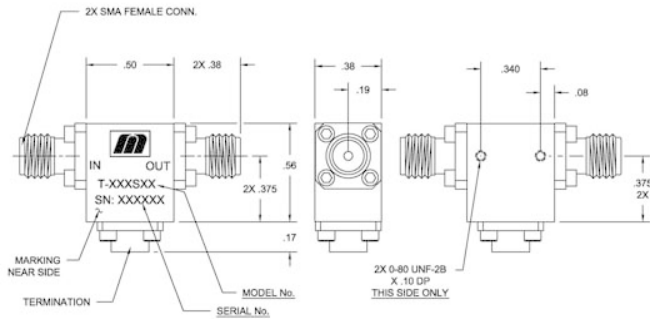

Specifications

RF Frequency	10 GHz to 20 GHz
Isolation	17 dB (min)
Insertion Loss	0.7 dB (max)
VSWR	1.35:1
Peak Power	10 Watts (max)
Average Power	1 Watts (max)
Package Size	0.50 x 0.56 x 0.38"

Environmental

Operating Temperature	-10 to 70 °C
-----------------------	--------------

Notes



Microwave RF Components | Manteca, CAL | 1-209-825-3977 | rf.mrcy.com
 Specifications subject to change without notice

