

SPEC SHEET

B30V

3 to 7 GHz

Double Balanced Mixers



Specifications

RF Frequency	3 to 7 GHz
LO Frequency	4 to 8 GHz
LO Power	16 dBm typ

Transfer Characteristics

Conversion Loss	5.5 dB typ 7 dB max
IF Frequency	DC to 2 GHz
LO to RF Isolation	25 dB min 38 dB typ
LO to IF Isolation	20 dB min 35 dB typ
IP3 In	19 dBm typ
P1dB In	10 dBm typ

Available Package Styles

Available Package Styles

W1,X,Y,Z

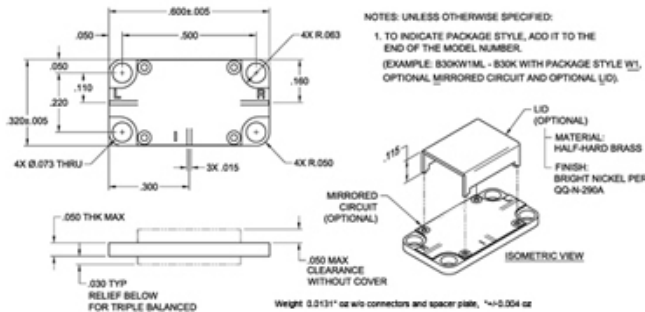

X PACKAGE

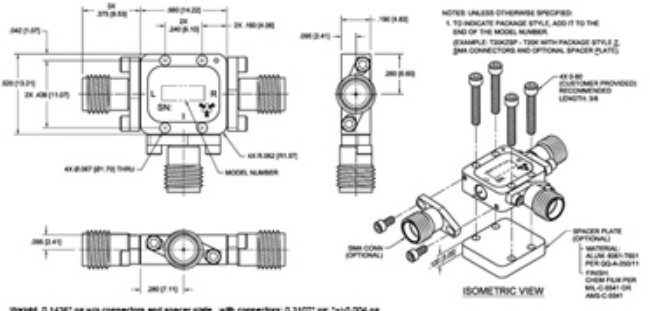
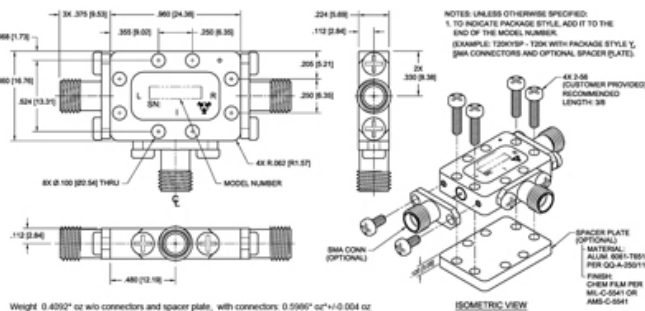
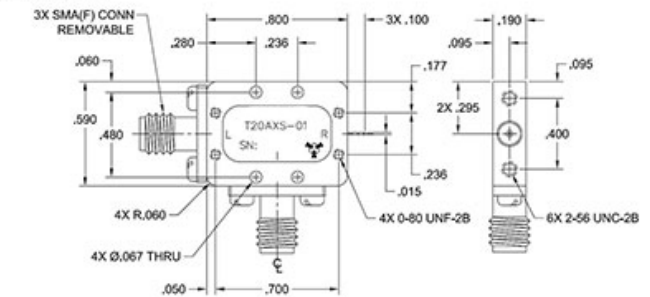

Environmental Ratings

Operating Temp -55 °C to 100 °C

Notes



Microwave RF Components | Manteca, CAL | 1-209-825-3977 | rf.mrcy.com
Specifications subject to change without notice

[Request a Quote](#) | [Ask an Engineer](#)  