

SPEC SHEET

B50K

5 to 18 GHz

Double Balanced Mixers



Specifications

RF Frequency	5 to 18 GHz
LO Frequency	5 to 18 GHz
LO Power	10 dBm typ

Transfer Characteristics

Conversion Loss	6.2 dB typ 8 dB max
IF Frequency	DC to 4 GHz
LO to RF Isolation	22 dB min 35 dB typ
LO to IF Isolation	20 dB min 30 dB typ
IP3 In	14 dBm typ
P1dB In	4 dBm typ

Available Package Styles

Available Package Styles

W1,X,Y,Z

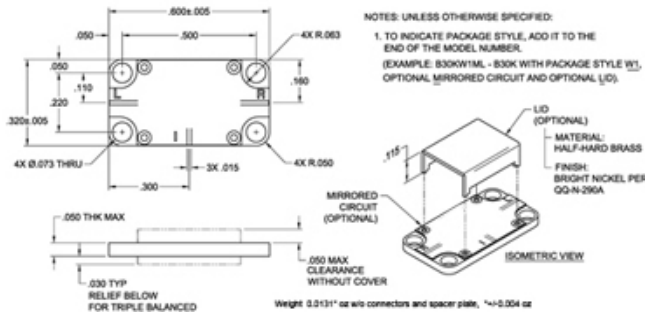

X PACKAGE

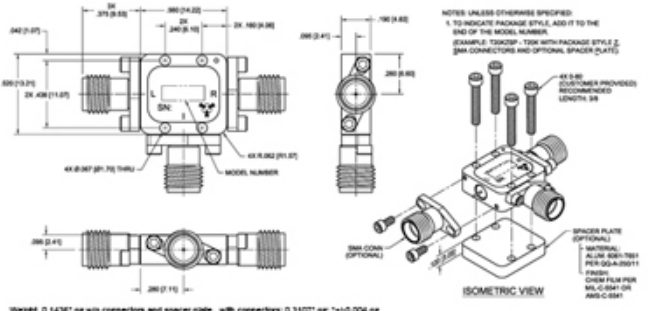
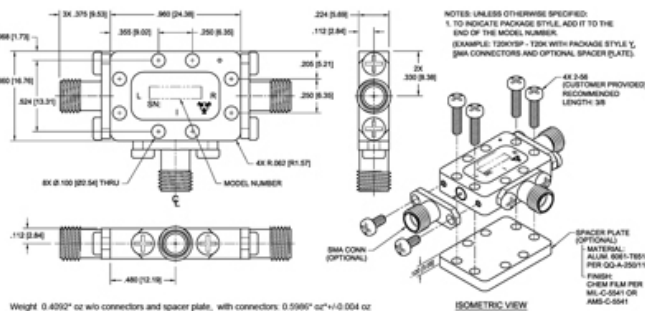
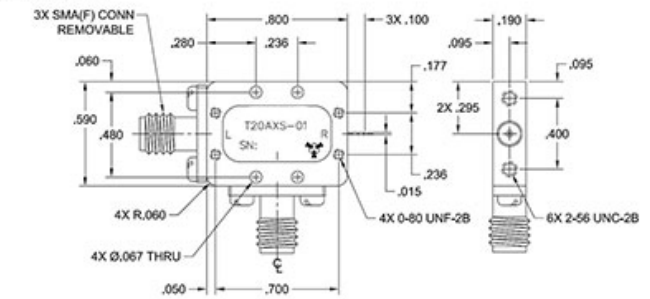

Environmental Ratings

Operating Temp -55 °C to 100 °C

Notes



Microwave RF Components | Manteca, CAL | 1-209-825-3977 | rf.mrcy.com
Specifications subject to change without notice

[Request a Quote](#) | [Ask an Engineer](#)  