

SPEC SHEET
B90H
9 to 16 GHz
 Double Balanced Mixers



Specifications

RF Frequency	9 to 16 GHz
LO Frequency	10 to 17 GHz
LO Power	7 dBm typ

Transfer Characteristics

Conversion Loss	5.5 dB typ 7 dB max
IF Frequency	DC to 3 GHz
LO to RF Isolation	25 dB min 35 dB typ
LO to IF Isolation	20 dB min 35 dB typ
IP3 In	11 dBm typ
P1dB In	1 dBm typ

Available Package Styles

Available Package Styles

W1,X,Y,Z

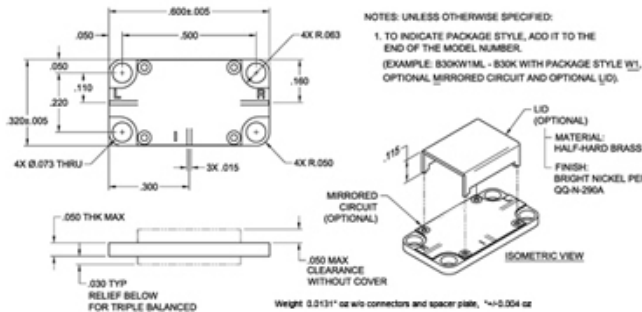

X PACKAGE

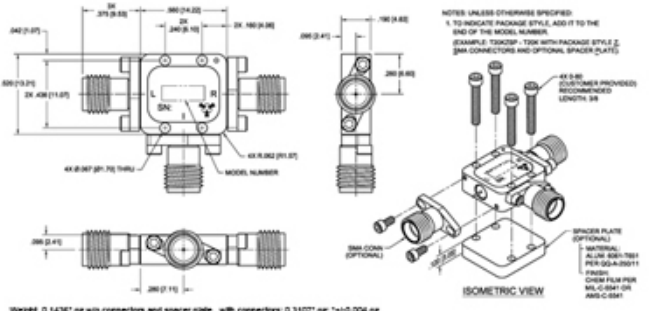
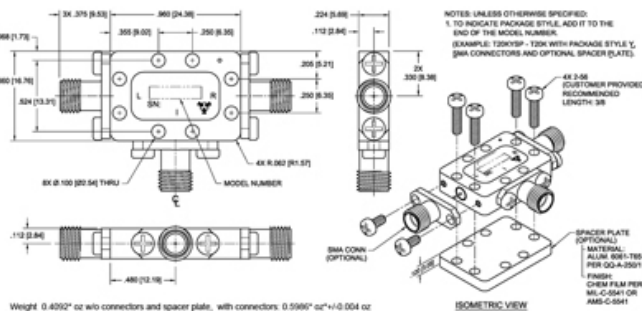
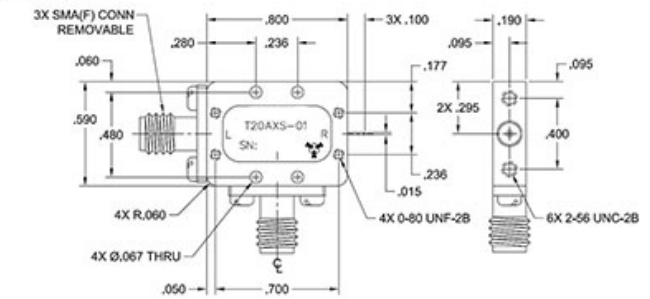

Environmental Ratings

Operating Temp -55 °C to 100 °C

Notes



Microwave RF Components | Manteca, CAL | 1-209-825-3977 | rf.mrcy.com
Specifications subject to change without notice

[Request a Quote](#) | [Ask an Engineer](#)  