

NST18L-A

10 MHz to 18 GHz

Broadband Microwave Coaxial Noise Sources

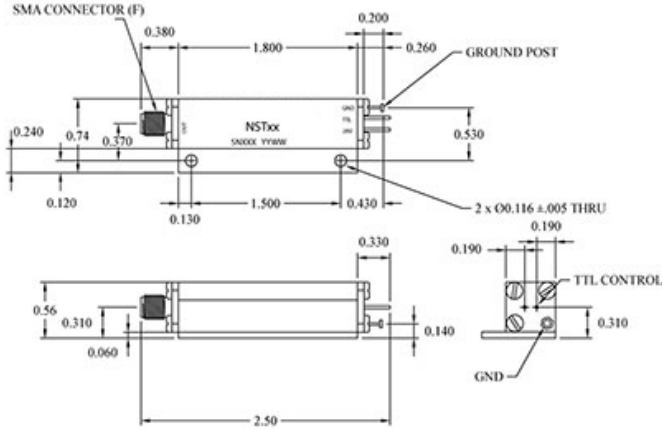

Specifications

RF Frequency	10 MHz to 18 GHz
Noise Output	13 - 17 dB ENR
Noise Spectral Density (N_0)	-159 dBm/Hz
VSWR	1.4:1
Peak Factor	5:01
Bias Voltage	28 V
Supply Current	25 mA Max
Impedance	50 ohms

Package and Connectivity

Construction	Coaxial
Connector Type	SMA(F)

Environmental

Operating Temperature	-55 to 95 °C
Storage Temperature	-65 to 125 °C

Notes



Microwave RF Components | Hudson, NH | (603) 546-4100 | rf.mrcy.com
 Specifications subject to change without notice

SMA CONNECTOR (F)

